

MAFR200 series

AIR UNIT (F.R.UNIT)

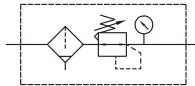

Symbol



Specification

Model	MAFR200	
Bore No.	6A	8A
Port size	1/8	1/4
Medium	Air	
Operating pressure range (*)	0.05~1 MPa	
Proof pressure	1.5 MPa	
Regulated pressure range	Standard: 0.05~0.85 MPa	
Ambient temperature	- 5~+60°C (No freezing)	
Filter element	Standard: 40µm, Option: 5 µm	
Drain capacity	9.5 cm ³ , 25 cm ³ (MAFR200L)	
Attachment	Pressure gauge (PG-40), L-type bracket	
Weight	257 g, 226 g (MAFR200L)	

* Standard unit contains semi-auto-drain function when operating pressure below 0.05 MPa.

Order example

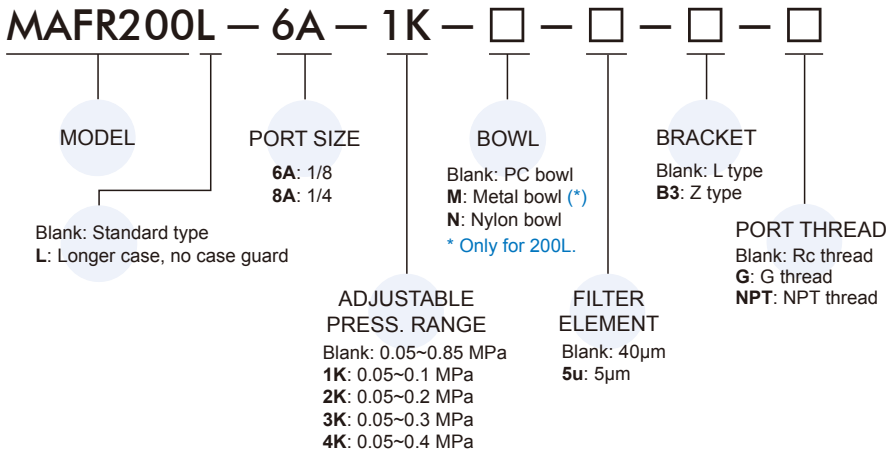

Flow feature

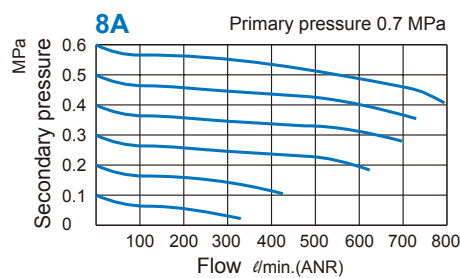
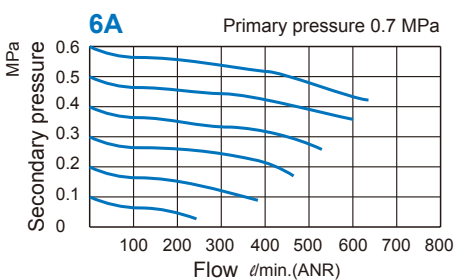

MAFR200 Dimensions

AIR UNIT (F.R.UNIT)



MAFR200-B3

Z type bracket

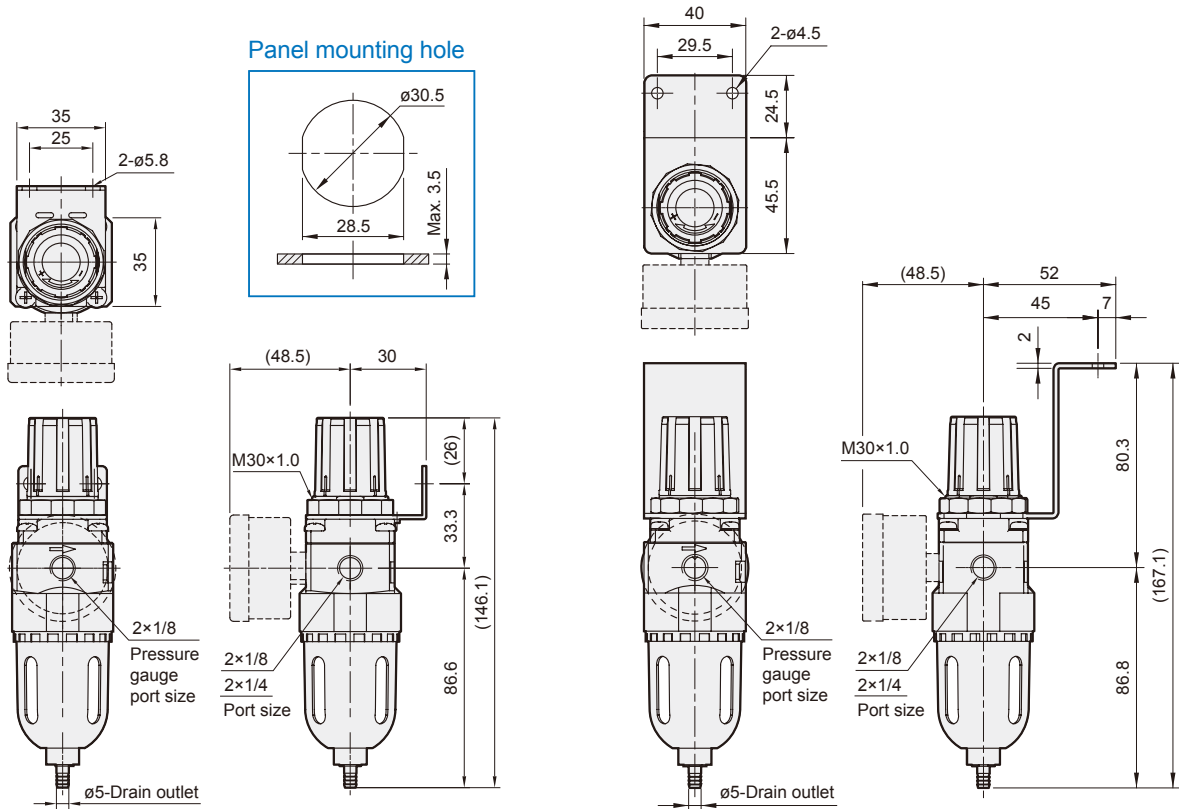

MAFR200L-M

Metal bowl + L type bracket

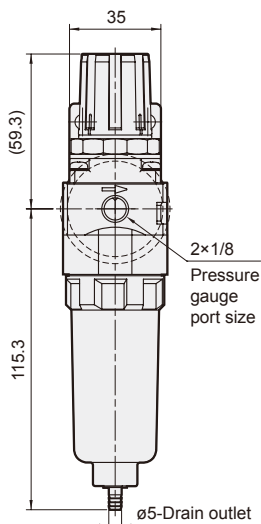

MAFR200L

L type bracket

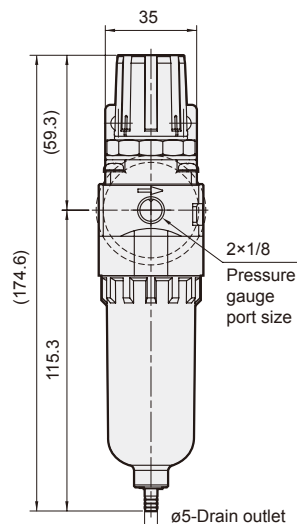

MAFR200L-B3

Z type bracket

